

Regolo

design Lievore Altherr Molina

SOVET
ITALIA

Tavolino triangolare disponibile con top in vetro stratificato nero oppure top in legno, varie finiture.

Nella versione top in vetro la base è composta da un elemento in vetro fumé e da un elemento in legno.

Nella versione top in legno la base è composta da un elemento in vetro fumé e un elemento in vetro stratificato nero.

Triangular coffee table available with top in black laminated glass or in wood, various finishes.

In the glass top version the base is composed of a smoked glass element and a wooden element.





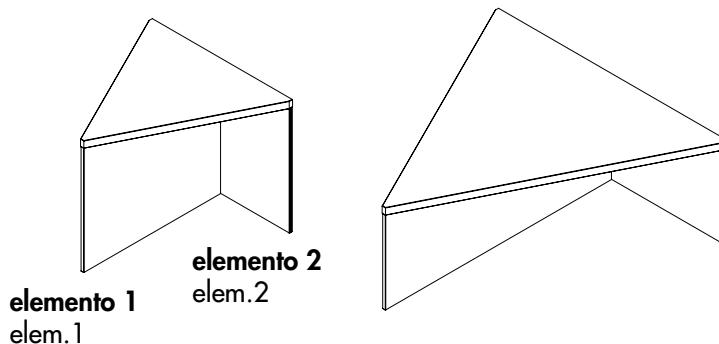

In the wooden top version the base is made up of a smoked glass element and a black laminated glass element.

FORME E DIMENSIONI / SHAPES AND DIMENSIONS

▲ 55x55x45h

▲ 90x90x35h



FINITURE ELEMENTO 1 / ELEMENT 1 FINISHES		FINITURE ELEMENTO 2 / ELEMENT 2 FINISHES		FINITURE TOP / TOP FINISHES	
VETRO FUMÉ SMOKED GLASS	LEGNO WOOD	VETRO STRATIFICATO LAMINATED GLASS	LEGNO WOOD	VETRO STRATIFICATO LAMINATED GLASS	
TFTF	RN/RG/WG	TFN1	RN/RG/WG	TFN1	
 TFTF	 RN RG WG	 TFN1	 RN RG WG	 TFN1	
 TFTF	 RN RG WG			 TFN1	