

# GLENN

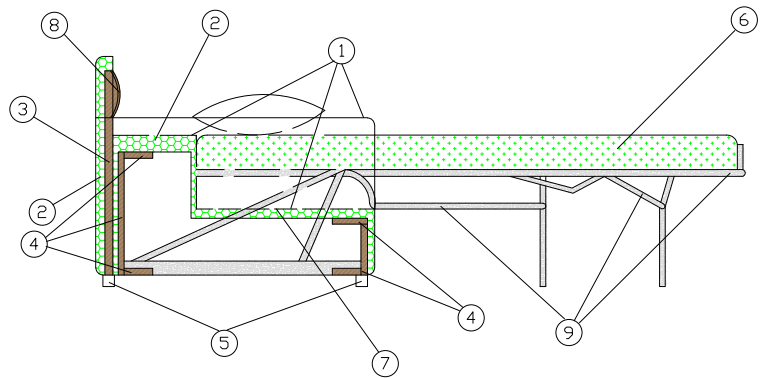
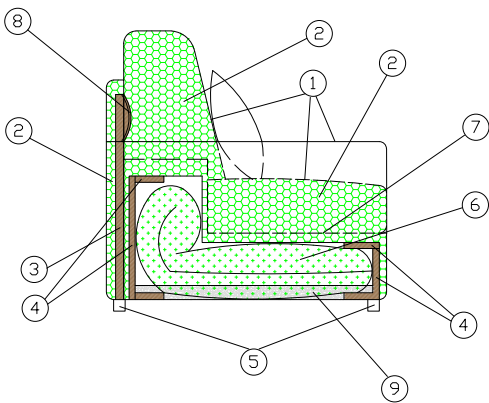

## MATERIALI:

- 1- fibra di dacron® 100 gr;
- 2- cuscino seduta in poliuretano espanso flessibile, cuscino schienale in piuma e poliuretano espanso indeformabile;
- 3- tavola in agglomerato di legno;
- 4- telaio in agglomerato di legno;
- 5- piedi in PVC;

- 6- materasso in poliuretano espanso a due pieghe normale o ignifugo, h 12 cm, rivestito con tessuto anallergico composto da poliestere;
- 7- cinghie elastiche intrecciate;
- 8- cuffia in legno di masonite;
- 9- rete elettrosaldata di acciaio ad alta resistenza.

# GLENN

## BRACCIOLO:



## GLENN COLLECTION:

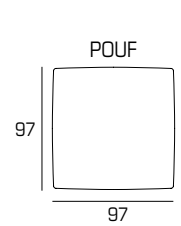
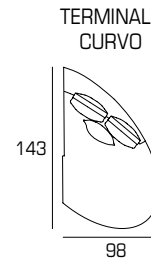
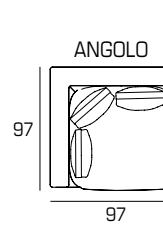
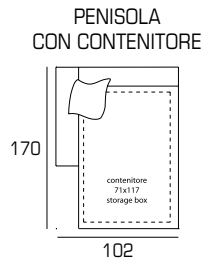
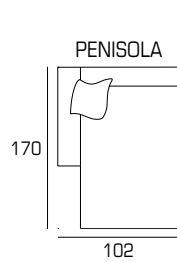
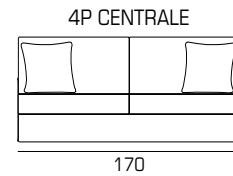
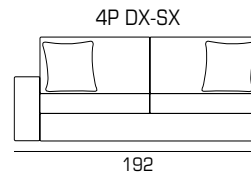
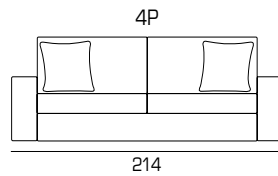
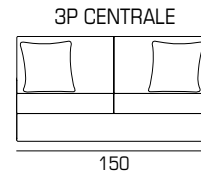
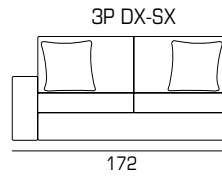
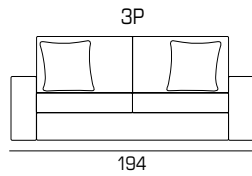
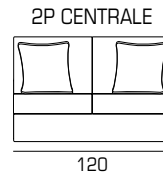
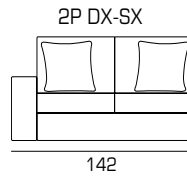
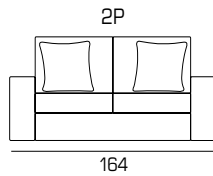
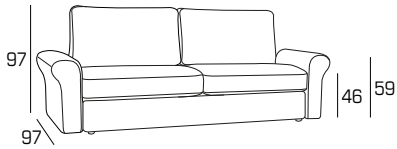

## PIEDI:

P 25 h 2-4-6

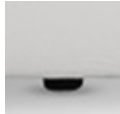

## LETTO:

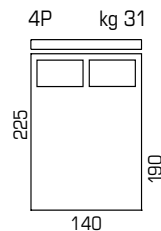
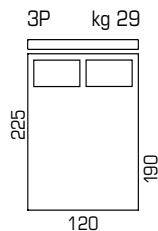
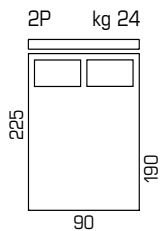

## MECCANISMO LETTO:

### Apertura

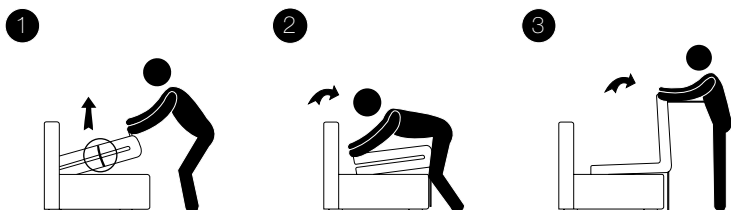

RIMUOVERE  
le fascette ai lati prima  
di sollevare la rete

Un'errata apertura del letto  
può provocare  
la rottura del meccanismo

### Chiusura

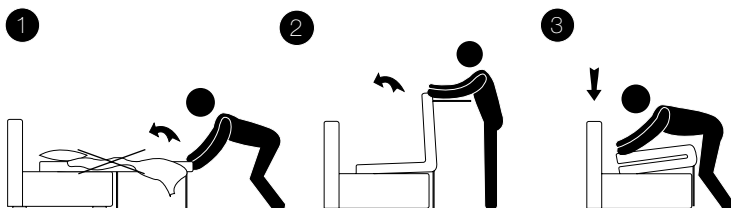

RIMUOVERE  
lenzuola, coperte o cuscini prima  
della chiusura del letto per evitare  
danni al meccanismo

## INFORMAZIONI TECNICHE:

Sfoderabile: NO	kg	m <sup>3</sup>	mts		kg	m <sup>3</sup>	mts
GLENN 2P	69	1.55	9.80	GLENN 4P LATERALE	87	1.80	10.00
GLENN 2P LATERALE	57	1.30	8.20	GLENN 4P CENTRALE	75	1.60	8.50
GLENN 2P CENTRALE	45	1.10	7.00	GLENN PENISOLA	83	1.65	8.50
GLENN 3P	90	1.30	8.80	GLENN PENISOLA CON CONTENITORE	83	1.65	8.50
GLENN 3P LATERALE	78	1.60	9.10	GLENN ANGOLO	45	0.90	8.00
GLENN 3P CENTRALE	66	1.40	8.00	GLENN TERMINALE CURVO	46	1.35	8.10
GLENN 4P	99	2.00	11.20	GLENN POUF	26	0.90	3.80