

# DUFFY

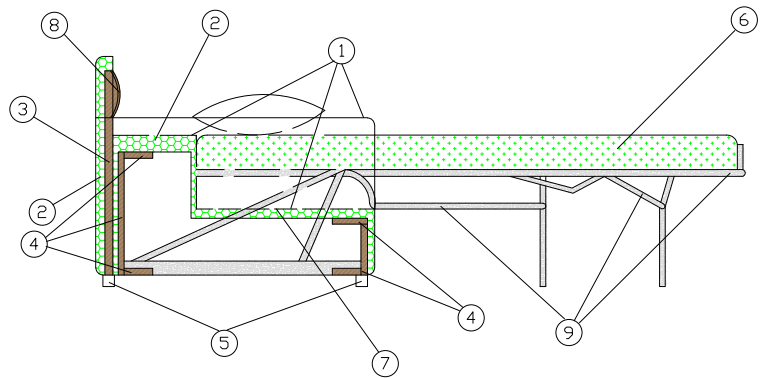
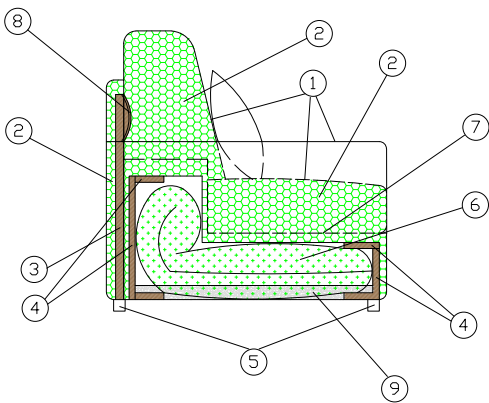

## MATERIALI:

- 1- fibra di dacron® 100 gr;
- 2- cuscino seduta in poliuretano espanso flessibile, cuscino schienale in piuma e poliuretano espanso indeformabile;
- 3- tavola in agglomerato di legno;
- 4- telaio in agglomerato di legno;
- 5- piedi in PVC;

- 6- materasso in poliuretano espanso a due pieghe normale o ignifugo, h 12 cm, rivestito con tessuto anallergico composto da poliestere;
- 7- cinghie elastiche intrecciate;
- 8- cuffia in legno di masonite;
- 9- rete elettrosaldada di acciaio ad alta resistenza.

# DUFFY

## BRACCIOLO:



## DUFFY COLLECTION:

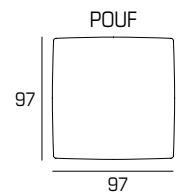
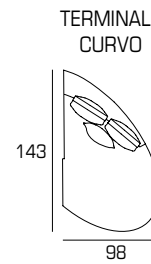
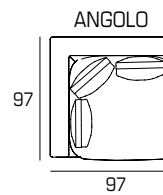
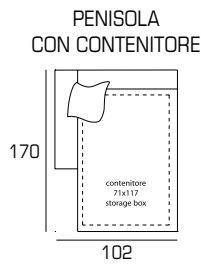
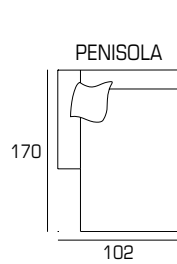
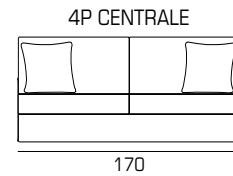
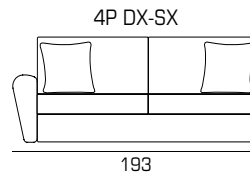
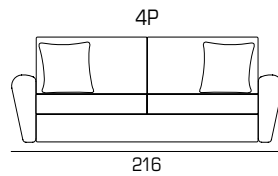
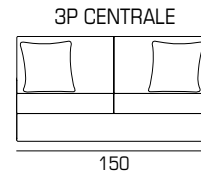
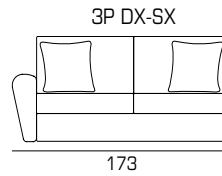
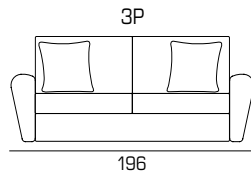
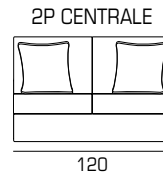
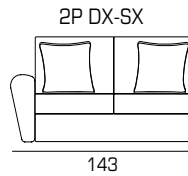
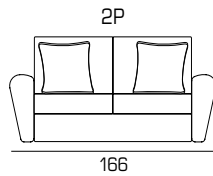
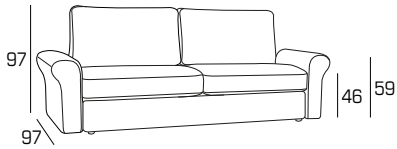

## PIEDI:

P 25 h 2-4-6

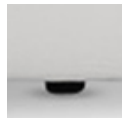

## LETTO:

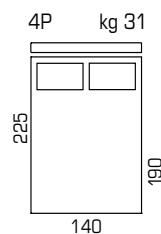
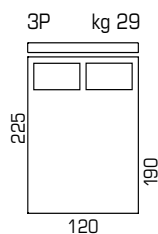
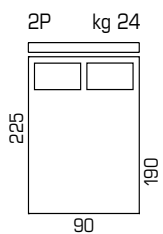

## MECCANISMO LETTO:

### Apertura

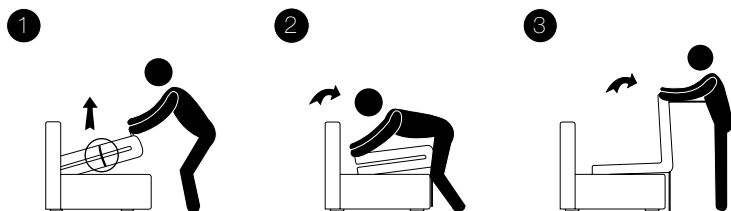

#### RIMUOVERE

le fascette ai lati prima di sollevare la rete

Un'errata apertura del letto può provocare la rottura del meccanismo

### Chiusura

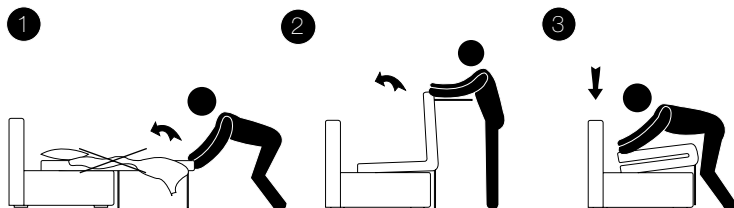

#### RIMUOVERE

lenzuola, coperte o cuscini prima della chiusura del letto per evitare danni al meccanismo

## INFORMAZIONI TECNICHE:

Sfoderabile: NO	kg	m <sup>3</sup>	mts		kg	m <sup>3</sup>	mts
DUFFY 2P	91	1.56	11.20	DUFFY 4P DX-SX	86	1.80	9.55
DUFFY 2P DX-SX	56	1.35	8.15	DUFFY 4P CENTRALE	75	1.60	8.50
DUFFY 2P CENTRALE	45	1.10	7.00	DUFFY PENISOLA	81	1.70	8.50
DUFFY 3P	117	1.80	12.10	DUFFY PENISOLA CON CONTENITORE	81	1.70	8.50
DUFFY 3P DX-SX	77	1.60	9.05	DUFFY ANGOLO	45	0.90	7.90
DUFFY 3P CENTRALE	66	1.40	8.00	DUFFY TERMINALE CURVO	46	1.35	8.10
DUFFY 4P	128	2.00	14.20	DUFFY POUF	26	0.90	3.80